

Profil
T-Profil hoch ET-02-10, 3m, Silber

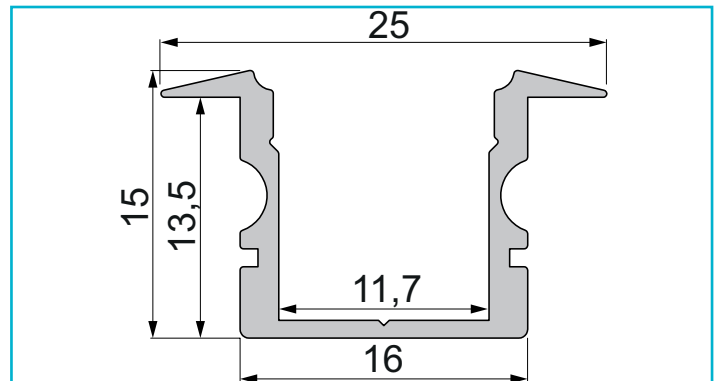

Besonderheiten

















- für LED-Stripes bis 11,3 mm Breite

Gehäusematerial	Aluminium
Gehäusefarbe	Silber
Oberflächenstruktur	Matt, Eloxiert
Montageort	Innen, Außen
Wärmeleitfähigkeit	900 J/(kg*K)
Länge	3000 mm
Breite	25 mm
Höhe	15 mm
Artikelgewicht	500 g

Zubehör .

- 978130  Endkappe P-ET-02-10 Set 2 Stk, Weiß, Kunststoff, Weiß
- 978131  Endkappe P-ET-02-10 Set 2 Stk, Grau, Kunststoff, Grau
- 978132  Endkappe P-ET-02-10 Set 2 Stk, Schwarz, Kunststoff, Schwarz
- 978630  Endkappe F-ET-02-10 Set 2 Stk, Weiß, Kunststoff, Weiß
- 978631  Endkappe F-ET-02-10 Set 2 Stk, Grau, Kunststoff, Grau
- 978632  Endkappe F-ET-02-10 Set 2 Stk, Schwarz, Kunststoff, Schwarz
- 979060  Endkappe H-ET-02-10 Set 2 Stk, Weiß, Kunststoff, Weiß
- 979061  Endkappe H-ET-02-10 Set 2 Stk, Grau, Kunststoff, Grau
- 979062  Endkappe H-ET-02-10 Set 2 Stk, Schwarz, Kunststoff, Schwarz
- 979560  Endkappe R-ET-02-10 Set 2 Stk, Weiß, Kunststoff, Weiß

Zubehör .

- 979561  Endkappe R-ET-02-10 Set 2 Stk, Grau, Kunststoff, Grau
- 979562  Endkappe R-ET-02-10 Set 2 Stk, Schwarz, Kunststoff, Schwarz
- 980060  Endkappe L-ET-02-10 Set 2 Stk, Weiß, Kunststoff, Weiß
- 980061  Endkappe L-ET-02-10 Set 2 Stk, Grau, Kunststoff, Grau
- 983010  Abdeckung P-01-10, 1m, klar, PMMA, Transparent 95% Transmission, 1000 mm
- 983012  Abdeckung P-01-10, 1m, matt, PMMA, Teiltransparent 75% Transmission, 1000 mm
- 983014  Abdeckung P-01-10, 1m, milchig, PMMA, Satiniert 40% Transmission, 1000 mm
- 983016  Abdeckung P-01-10, 3m, klar, PMMA, Transparent 95% Transmission, 3000 mm
- 983017  Abdeckung P-01-10, 3m, matt, PMMA, Teiltransparent 75% Transmission, 3000 mm
- 983018  Abdeckung P-01-10, 3m, milchig, PMMA, Satiniert 40% Transmission, 3000 mm
- 983510  Abdeckung F-01-10, 1m, klar, PMMA, Transparent 95% Transmission, 1000 mm
- 983512  Abdeckung F-01-10, 1m, matt, PMMA, Teiltransparent 75% Transmission, 1000 mm
- 983514  Abdeckung F-01-10, 1m, milchig, PMMA, Satiniert 40% Transmission, 1000 mm
- 983516  Abdeckung F-01-10, 3m, klar, PMMA, Transparent 95% Transmission, 3000 mm
- 983517  Abdeckung F-01-10, 3m, matt, PMMA, Teiltransparent 75% Transmission, 3000 mm
- 930345  3M Doppelseitiges Klebeband 50000x8x0,2mm
- 930346  3M Doppelseitiges Klebeband 50000x10x0,2mm
- 930347  3M Doppelseitiges Klebeband 50000x12x0,2mm

Profil
T-Profil hoch ET-02-10, 3m, Silber

Zubehör •

- 930348**  3M Doppelseitiges Klebeband 50000x15x0,2mm
- 987004**  2er Set Halteklammern für AU-10, Metall
- 987080**  Universal Halteclip Aufnahme (schwenkbar) Set 2 Stk, Metall, Silber