

Artikel Nr.: 979501

Endkappe R-AU-01-10 Set 2 Stk passend für

Charakteristik

Material	Kunststoff
Farbe	Grau
Optik	



Abmessungen und Gewicht

Länge	16 mm
Breite	6 mm
Höhe	15,5 mm
Durchmesser	
Gewicht	2 g

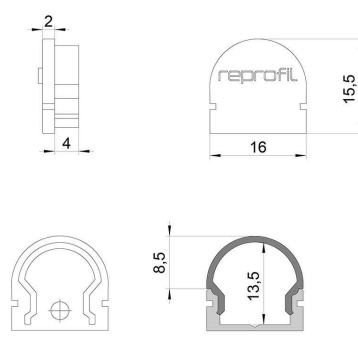

Montage

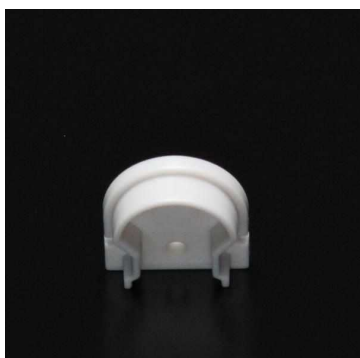

Befestigungsmöglichkeiten

Artikel Nr.: 979501

End Cap R-AU-01-10 Set 2 pcs suitable for

Characteristics

Material	plastic
Color	gray
Optic	



Dimensions & Weight

Length	16 mm
Width	6 mm
Height	15,5 mm
Diameter	
Product Weight	2 g

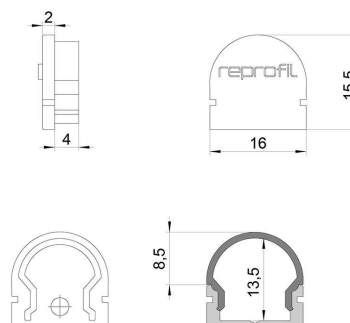

Mounting



Mounting Options