

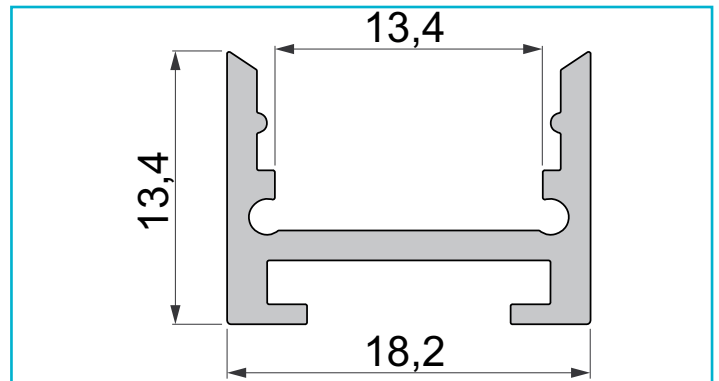





Profil
Nuten-Profil, U-hoch AU-10-12, 3m, Weiß
**Besonderheiten**











- für LED-Stripes bis 13 mm Breite

Gehäusematerial	Aluminium
Gehäusefarbe	Weiß
Oberflächenstruktur	Matt, Pulverbeschichtet
Montageort	Innen, Außen
Wärmeleitfähigkeit	900 J/(kg*K)
Länge	3000 mm
Breite	18,2 mm
Höhe	13,7 mm
Artikelgewicht	400 g

Zubehör .

- 983098**  Abdeckung Rolle P-10-12, 20m, klar, Polycarbonat, KlarFarblos, 20000 mm
- 980023**  Montageclip, Set (2 Stk.), Kunststoff, Weiß
- 987025**  Nutenstein / Längsverbinder, Metall, Silber
- 987026**  Nutenstein / Eckverbinder 120°, Metall, Silber
- 987027**  Nutenstein / Eckverbinder 90°, Metall, Silber

Zubehör .

- 980020**  Endkappe P-AU-10-12 Set 2 Stk, Silber, Aluminium, Silber
- 980021**  Endkappe P-AU-10-12 Set 2 Stk, Silber, Aluminium, Silber
- 983090**  Abdeckung P-10-12, 2m, milchig, Polycarbonat, Satiniert 40% TransmissionWeiß, 2000 mm
- 983091**  Abdeckung P-10-12, 3m, milchig, Polycarbonat, Satiniert 40% TransmissionWeiß, 3000 mm
- 983092**  Abdeckung Rolle P-10-12, 20m, milchig, Polycarbonat, Satiniert 40% TransmissionWeiß, 20000 mm
- 983093**  Abdeckung P-10-12, 2m, schwarz, Polycarbonat, Schwarz, 2000 mm
- 983094**  Abdeckung P-10-12, 3m, schwarz, Polycarbonat, Schwarz, 3000 mm
- 983095**  Abdeckung Rolle P-10-12, 20m, schwarz, Polycarbonat, Schwarz, 20000 mm
- 983096**  Abdeckung P-10-12, 2m, klar, Polycarbonat, KlarFarblos, 2000 mm
- 983097**  Abdeckung P-10-12, 3m, klar, Polycarbonat, KlarFarblos, 3000 mm