

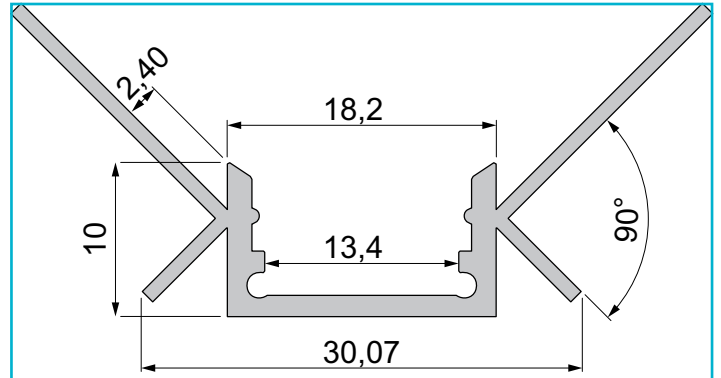
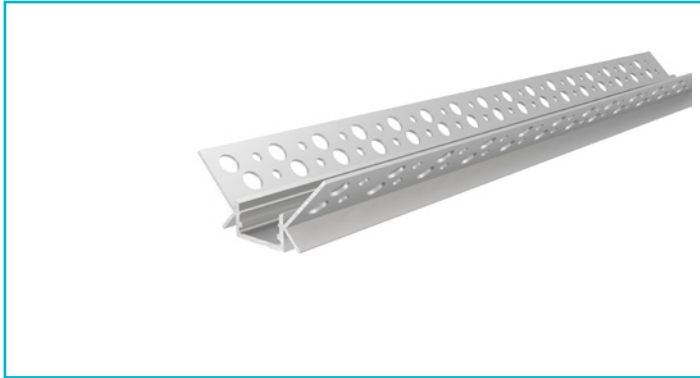

Profil
Trockenbau-Profil, EV-11-12, 3m, Silber
**Besonderheiten**

- für LED-Stripes bis 12 mm Breite

Gehäusematerial	Aluminium
Gehäusefarbe	Silber
Oberflächenstruktur	Matt, Eloxiert
Wärmeleitfähigkeit	900 J/(kg*K)
Länge	3000 mm
Artikelgewicht	740 g

Zubehör •

983090	 Abdeckung P-10-12, 2m, milchig, Polycarbonat, Satiniert 40% TransmissionWeiß, 2000 mm
983091	 Abdeckung P-10-12, 3m, milchig, Polycarbonat, Satiniert 40% TransmissionWeiß, 3000 mm
983092	 Abdeckung Rolle P-10-12, 20m, milchig, Polycarbonat, Satiniert 40% TransmissionWeiß, 20000 mm
983093	Abdeckung P-10-12, 2m, schwarz, Polycarbonat, Schwarz, 2000 mm
983094	Abdeckung P-10-12, 3m, schwarz, Polycarbonat, Schwarz, 3000 mm
983095	 Abdeckung Rolle P-10-12, 20m, schwarz, Polycarbonat, Schwarz, 20000 mm
983096	Abdeckung P-10-12, 2m, klar, Polycarbonat, KlarFarblos, 2000 mm
983097	Abdeckung P-10-12, 3m, klar, Polycarbonat, KlarFarblos, 3000 mm
983098	 Abdeckung Rolle P-10-12, 20m, klar, Polycarbonat, KlarFarblos, 20000 mm