

Artikel Nr.: 862181

Netzgerät, Multi CC, PRO-UA430-W Schienensystem 3-Phasen 230V











IP20 

Elektrische Daten

Betriebsart	stromkonstant	Eingangsspannung	220-240V AC/50-60Hz
Leistung	15,00-33,60 W	Leistungsfaktor	0,97
Ausgangsspannung	25-42V DC	Anschlußmöglichkeit	Klemme
Ausgangsstrom	600/700/750/800 mA		

Produkteigenschaften

 Schutzklasse I	 Überspannungsschutz
SELV Schutzkleinspannung	 Lampenbetriebsgerät 110
 Kurzschlußfest	 Möbeleinbau nicht geeignet
 Überlastschutz	ErP Standby-Stromverbrauch < 0,5 W
 Übertemperaturschutz	LVD Sicherheit nach EN 61347
 Sicherheitstrafo	EMC Funkentstörung + Störfestigkeit nach EN 55015 + EN 61547
 nicht dimmbar	EMC Netzstromoberwellen + Flicker nach EN 61000-3-2 + EN 61000-3-3

Schwarze Felder sind zutreffend / graue Felder sind nicht zutreffend

Artikel Nr.: 862181

Netzgerät, Multi CC, PRO-UA430-W Schienensystem 3-Phasen 230V

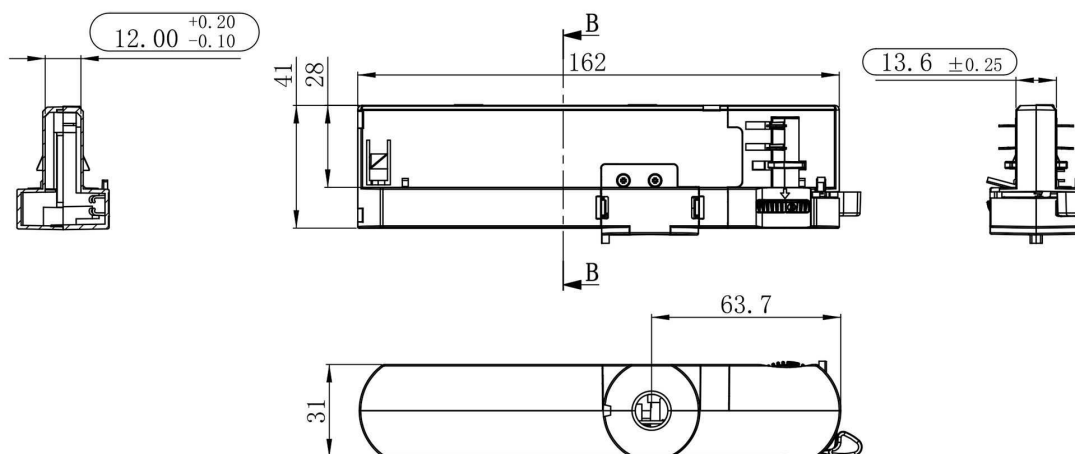

Abmessungen und Gewicht

Grenzwerte

Länge	162,00 mm	Betriebstemperatur	-20°C - +35°C
Breite	31,00 mm	Gehäusetemperatur	75 °C
Höhe	41,00 mm	max. Menge Sicherungsautomaten	
Durchmesser	0,00 mm	max. Einschaltstrom	
Gewicht	113 g	kapazitive Last	

Multi-CC variable Leistungs-/Spannungsbereiche / Multi-CC variable power/voltage ranges

Stromstärke / Current	Leistung / Power	Spannung / Voltage
600mA	15,00W - 25,20W	25V - 42V
700mA	17,50W - 29,40W	25V - 42V
750mA	18,75W - 31,50W	25V - 42V
800mA	20,00W - 33,60W	25V - 42V

max. 2 Lampen je Kanal - Spannungsbereich überprüfen! / max. 2 lamps per channel - check voltage range!

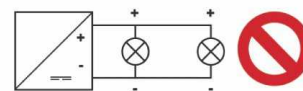
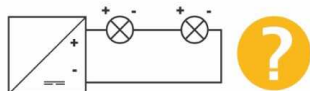









Article No.: 862181

Power supply unit, Multi CC, PRO-UA430-W Track system 3-Phases 230V

**IP20 CE****Electrical Characteristics**

Operating mode	constant voltage	Input voltage	220-240V AC/50-60Hz
Power	15,00-33,60 W	Power factor	0,97
Output voltage	25-42V DC	Connection possibility	clamp
Output current	600/700/750/800 mA		

Product features

	Protection class I		Overvoltage protection
SELV	Low voltage protection		Lamp control gear 110
	Short circuit protection		Not suitable for furniture installation
	Overload protection	ErP	Standby-power consumption < 0,5 W
	Overheating protection	LVD	Safety according to EN 61347
	Safety transformer	EMC	Interference suppression + immunity according to EN 55015 + EN 61547
	not dimmable	EMC	Mains harmonics + flicker according to EN 61000-3-2 + EN 61000-3-3

Black fields are applicable / gray fields are not applicable

Article No.: 862181

Power supply unit, Multi CC, PRO-UA430-W Track system 3-Phases 230V

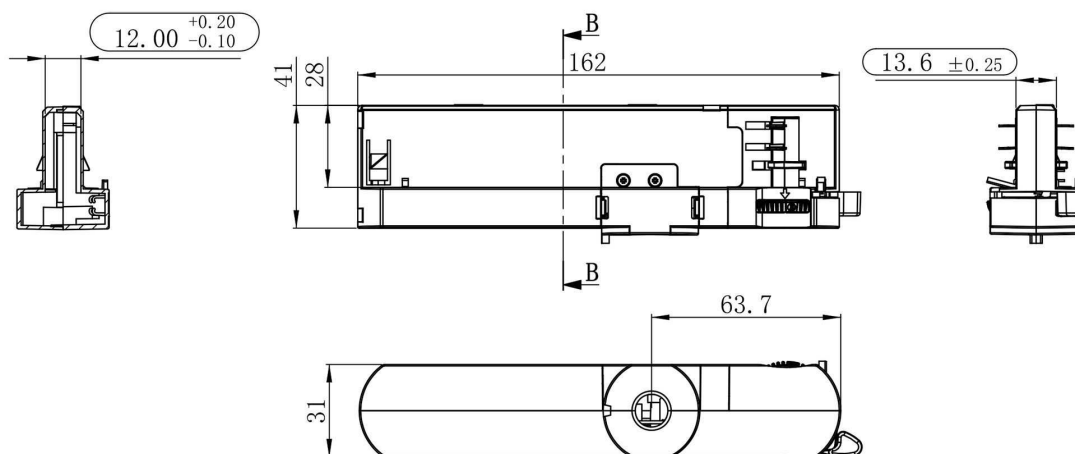

Dimensions & Weight

Absolute maximum ratings

Length	162,00 mm	Operating temperature	-20°C - +35°C
Width	31,00 mm	Case temperature	75 °C
Height	41,00 mm	max. amount of circuit breakers	
Diameter	0,00 mm	max. inrush current	
Product weight	113 g	capacitive load	

Multi-CC variable Leistungs-/Spannungsbereiche / Multi-CC variable power/voltage ranges

Stromstärke / Current	Leistung / Power	Spannung / Voltage
600mA	15,00W - 25,20W	25V - 42V
700mA	17,50W - 29,40W	25V - 42V
750mA	18,75W - 31,50W	25V - 42V
800mA	20,00W - 33,60W	25V - 42V

max. 2 Lampen je Kanal - Spannungsbereich überprüfen! / max. 2 lamps per channel - check voltage range!

